















Kombinationsmöglichkeiten

RFK 2 / Stiftheisten

Board to Board / Wire to Board Federleisten Board to Board / Wire to Board Socket connectors						
Seite / Page		8	12-15	9	10	10
18	 MKS 1650 MKS 1750	●		●	●	●
19		●		●	●	●
20	 MKS 2650 MKS 2670 MKS 2750 MKS 2770	●			●	●
22		●			●	●
21		●			●	●
23		●			●	●
24	 MKS 6130 MKS 6150 MKS 6260	●		●	●	●
25		●		●	●	●
26		●		●	●	●
27	 MKS 1850 MKS 1950	●		●	●	●
27		●		●	●	●
28	 MKS 2620 MKS 2850 MKS 2950 MKS 2970	●			●	●
30		●			●	●
31		●			●	●
29		●			●	●
32	 MKS 6180 MKS 6200 MKS 6230 MKS 6530	●		●	●	●
33		●		●	●	●
34		●		●	●	●
35		●		●	●	●
36	 MKS 11850 MKS 12850	●				
37		●				
44	 MGZ 8527 MGZ 8528 MGZ 8529	●		●		
44		●		●		
45		●		●		
42	 MGZ 1049 MGZ 1059 MGZ 1079 MGZ 1100					
42						
42						
43						
	 Platinenrand geschlitzt PCB edge slot position		●			

Combination alternatives

RFK 2 / Pin strips



MKF 16000
MKF 16010

MKH 5130

MKH 5630

MKF 19480

MKF 19390

MGF 9000

MGF 9100

11

16

17

40

41

38

39

•
•

•
•

•
•

•
•

•
•

•
•
•
•

•
•
•
•

•
•

•
•

•
•
•

•
•
•

•
•
•

•
•
•

•
•
•

•
•

•
•

•
•

•
•

•
•

•
•
•
•

•
•
•
•

•
•

•
•

•
•
•
•

•
•
•
•

•
•
•
•

•
•
•
•

•
•
•
•

•
•

•
•

•
•
•

•
•
•

•
•
•

•
•
•

•
•
•
•

•
•
•
•

RFK 2

Systembeschreibung / Description of system

Systembeschreibung

Wire to Board-Federleisten (WtB):

- mit Crimpanschluß als Indirektsteckverbinder, Querschnittsbereich 0,07 - 0,5 mm²
- mit Schneidklemmanschluß als Direkt- und Indirektsteckverbinder, Querschnittsbereich 0,14 - 0,25 mm²
- es können sowohl Flachband- als auch Einzelleitungen angeschlagen werden
- die Federleisten sind auch mit Kabelknickschutz und Codierbeinen lieferbar

Stiftwannen:

- mit und ohne Rastlasche, in stehender und liegender Ausführung
- die Doppelstiftgehäuse können als fliegende Kupplung eingesetzt werden

Board to Board-Federleisten (BtB):

- Karte-Karte Steckverbinder in stehender und liegender Ausführung
- die Serien mit Rastzapfen oder Haken sind mit versetzten und einreihigen Lötanschlüssen lieferbar

Stiftleisten:

- einreihige Ausführung
- mehrreihige Versionen und größere Raster auf Anfrage

Bestellbeispiel:

10polige Federleiste in Schneidklemmtechnik für Rastersteg- und Einzelleiter, Massivdraht 0,4 mm Ø (oder Litze 0,14 mm²), mit 10 Kontakten bestückt.

Serie: MKF 13260
 Gehäuse Polzahl: 10
 Massivdraht 0,4 mm ø: 1
 Bestellnummer: MKF 13270 -6 -1 -1 -10 10

Serie + Polzahl
 Firmeninterne Nr.
 Kennziffer zu Leiter
 Gehäuse-Polzahl
 Anzahl der Kontakte

Description of system

Wire to Board socket connectors (WtB):

- crimp version for indirect connections, wire range 0.07 - 0.5 mm²
- IDC version for direct and indirect connections, wire range 0.14 - 0.25 mm²
- suitable for terminating ribbon cables and discrete wires
- also available with extended cable support and polarizing pegs

Pin connectors:

- with or without snap-in locking device, for vertical or horizontal connections
- the tandem pin connectors can be used as flying lead connection

Board to Board socket connectors (BtB):

- Board to Board connectors for vertical or horizontal connections
- the series with hooks or snap-in pegs are available with staggered and in line solder pins

Pin strips:

- in line version
- staggered versions and larger pitch sizes on request

Example for ordering:

10-way IDC socket connector loaded with 10 contacts for ribbon cable and discrete wire of 0.4 mm Ø (or stranded wire AWG 26).

Series: MKF 13260
 Housing-positions: 10
 Discrete wire 0.4 mm ø: 1
 Part number: MKF 13270 -6 -1 -1 -10 10

Series + positions
 Company's internal number
 Wire code number
 Housing positions
 Number of loaded contacts

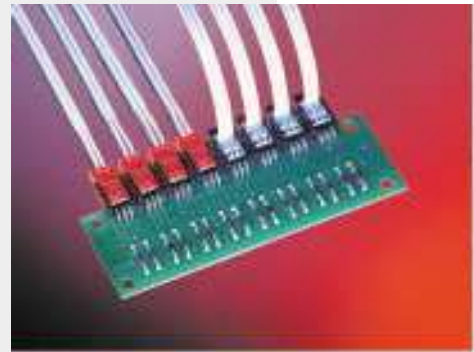

RFK 2

Technische Daten / *Technical Data*



Technische Daten *Technical data*

	WtB <i>WtB</i> (Seite 8 - 37) (Page 8 - 37)	BtB <i>BtB</i> (Seite 38 - 41) (Page 38 - 41)	Stiftleisten <i>Pin strips</i> (Seite 42 - 45) (Page 42 - 45)
Mechanisch <i>Mechanical</i>			
Raster <i>Pitch</i>	2,5 mm	2,5 mm	2,5 mm
Polzahl <i>Positions</i>	bis 20 <i>up to 20</i>	bis 21 <i>up to 21</i>	bis 40 <i>up to 40</i>
Anschlußart <i>Termination</i>	IDC, crimpen, löten <i>IDC, crimp, soldering</i>	löten <i>soldering</i>	löten <i>soldering</i>
Betriebstemperatur <i>Operating temperature</i>	-40 °C + 115 °C	-40 °C + 115 °C	-40 °C + 100 °C
Elektrisch <i>Electrical</i>			
Strombelastbarkeit <i>Current rating</i>	5A / 30 °C 2,5A / 70 °C	5A / 30 °C 2,5A / 70 °C	4A / 30 °C 1,5A / 70 °C
Isolationswiderstand <i>Insulation resistance</i>	> 10 ⁹ Ohm	> 10 ⁹ Ohm	> 10 ⁹ Ohm
Durchgangswiderstand <i>Contact resistance</i>	< 10 m Ohm	< 10 m Ohm	< 10 m Ohm
Prüfspannung <i>Test voltage</i>	1500 V AC	1500 V AC	1500 V AC
Werkstoffe <i>Materials</i>			
Isolierkörper <i>Housing</i>	PC-V0	PC-V0	PBT-V0/PPO-V0
Kontakt <i>Contact</i>	CuSn	CuSn	CuZn
Kontaktoberfläche <i>Finishing</i>	verzinkt <i>tin plated</i>	verzinkt <i>tin plated</i>	verzinkt <i>tin plated</i>

Detaillierte Informationen auf Anfrage!
Please ask for detailed data!

Federgehäuse mit Crimpanschluß Housings with crimp connection

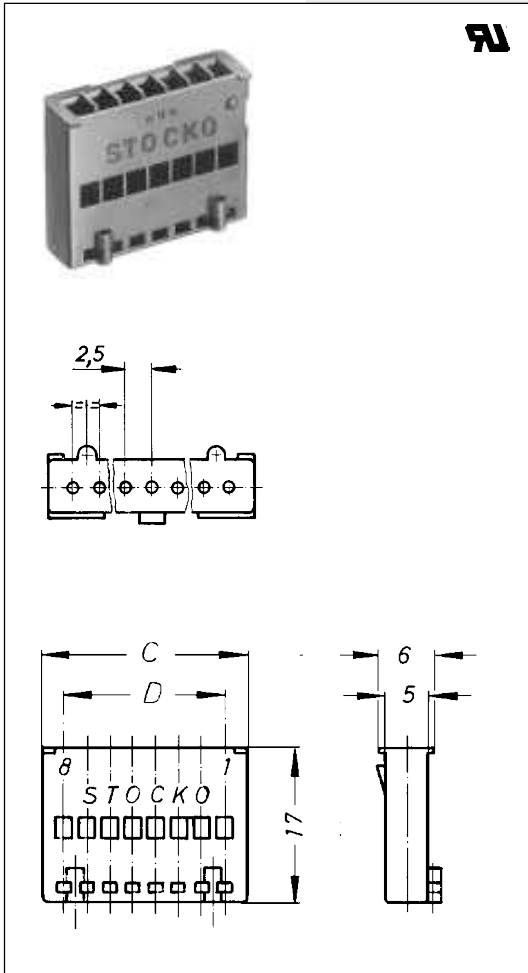

Serie MKH 5130 für Einzelleiter Series MKH 5130 for discrete wire

Polzahl Positions	Artikel-Nummer Part number	Abmessungen C Dimensions C	Abmessungen D Dimensions D
2	MKH 5131 - 1 - 0 - 200	7,5	2,5
2	MKH 5132 - 1 - 0 - 200	5,7	2,5
3	MKH 5133 - 1 - 0 - 300	9,9	5,0
4	MKH 5134 - 1 - 0 - 400	12,4	7,5
5	MKH 5135 - 1 - 0 - 500	14,9	10,0
6	MKH 5136 - 1 - 0 - 600	17,4	12,5
7	MKH 5137 - 1 - 0 - 700	19,9	15,0
8	MKH 5138 - 1 - 0 - 800	22,4	17,5
9	MKH 5139 - 1 - 0 - 900	24,9	20,0
10	MKH 5140 - 1 - 0 - 1000	27,4	22,5
11	MKH 5141 - 1 - 0 - 1100	29,9	25,0
12	MKH 5142 - 1 - 0 - 1200	32,4	27,5
13	MKH 5143 - 1 - 0 - 1300	34,9	30,0
14	MKH 5144 - 1 - 0 - 1400	37,4	32,5
15	MKH 5145 - 1 - 0 - 1500	39,9	35,0
16	MKH 5146 - 1 - 0 - 1600	42,4	37,5
17	MKH 5147 - 1 - 0 - 1700	44,9	40,0
18	MKH 5148 - 1 - 0 - 1800	47,4	42,5
19	MKH 5149 - 1 - 0 - 1900	49,9	45,0
20	MKH 5150 - 1 - 0 - 2000	52,4	47,5



Crimpfeder

RFB 7808 V 0,6 - 0,5 für Leiterquerschnitt 0,07 - 0,5 mm²
mit Isolationsdurchmesser max. 1,9 mm.

Crimp contact

RFB 7808 V 0.6 - 0.5 for 0.07 - 0.5 mm² wire size,
max. insulation diameter 1.9 mm.

Stiftwannen, stehend, mit Rastlasche

Pin connectors with snap-in locking device for vertical connections

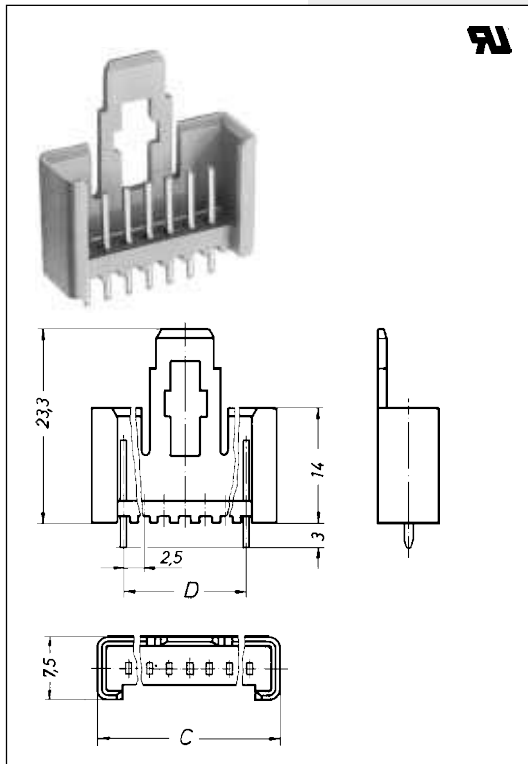

Serie MKS 1850, Lötstifte In-line Series MKS 1850, solder pins in line

Polzahl Positions	Artikel-Nummer Part number	Abmessungen C Dimensions C	Abmessungen D Dimensions D
2	MKS 1851 - 6 - 0 - 202	9,7	2,5
2*	MKS 1852 - 6 - 0 - 202	7,9	2,5
3	MKS 1853 - 6 - 0 - 303	12,2	5,0
4	MKS 1854 - 6 - 0 - 404	14,7	7,5
5	MKS 1855 - 6 - 0 - 505	17,2	10,0
6	MKS 1856 - 6 - 0 - 606	19,7	12,5
7	MKS 1857 - 6 - 0 - 707	22,2	15,0
8	MKS 1858 - 6 - 0 - 808	24,7	17,5
9	MKS 1859 - 6 - 0 - 909	27,2	20,0
10	MKS 1860 - 6 - 0 - 1010	29,7	22,5
11	MKS 1861 - 6 - 0 - 1111	32,2	25,0
12	MKS 1862 - 6 - 0 - 1212	34,7	27,5
13	MKS 1863 - 6 - 0 - 1313	37,2	30,0
14	MKS 1864 - 6 - 0 - 1414	39,7	32,5
15	MKS 1865 - 6 - 0 - 1515	42,2	35,0
16	MKS 1866 - 6 - 0 - 1616	44,7	37,5
17	MKS 1867 - 6 - 0 - 1717	47,2	40,0
18	MKS 1868 - 6 - 0 - 1818	49,7	42,5
20	MKS 1870 - 6 - 0 - 2020	54,7	47,5

* nur geeignet für Federleisten MKF 13216/13316 und MKH 5132

* only suitable for connectors MKF 13216/13316 and MKH 5132

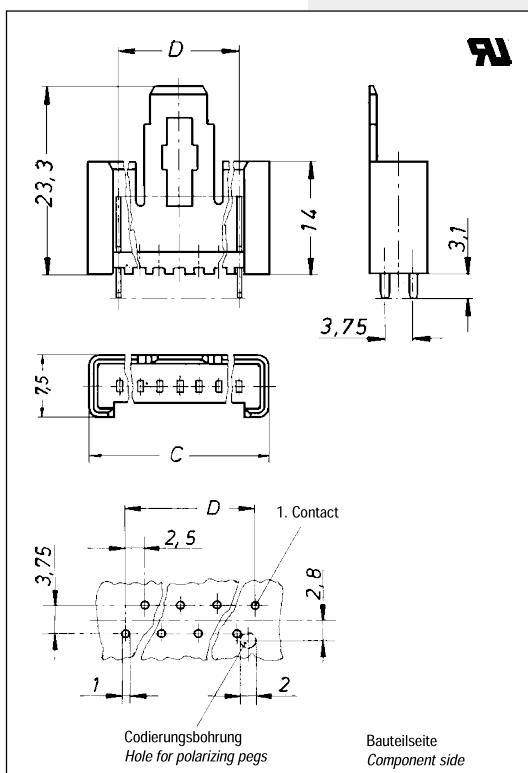

Serie MKS 1950, Lötstifte versetzt Series MKS 1950, solder pins staggered

Polzahl Positions	Artikel-Nummer Part number	Abmessungen C Dimensions C	Abmessungen D Dimensions D
2	MKS 1951 - 6 - 0 - 202	9,7	2,5
2*	MKS 1952 - 6 - 0 - 202	7,9	2,5
3	MKS 1953 - 6 - 0 - 303	12,2	5,0
4	MKS 1954 - 6 - 0 - 404	14,7	7,5
5	MKS 1955 - 6 - 0 - 505	17,2	10,0
6	MKS 1956 - 6 - 0 - 606	19,7	12,5
7	MKS 1957 - 6 - 0 - 707	22,2	15,0
8	MKS 1958 - 6 - 0 - 808	24,7	17,5
9	MKS 1959 - 6 - 0 - 909	27,2	20,0
10	MKS 1960 - 6 - 0 - 1010	29,7	22,5
11	MKS 1961 - 6 - 0 - 1111	32,2	25,0
12	MKS 1962 - 6 - 0 - 1212	34,7	27,5
13	MKS 1963 - 6 - 0 - 1313	37,2	30,0
14	MKS 1964 - 6 - 0 - 1414	39,7	32,5
15	MKS 1965 - 6 - 0 - 1515	42,2	35,0
16	MKS 1966 - 6 - 0 - 1616	44,7	37,5
17	MKS 1967 - 6 - 0 - 1717	47,2	40,0
18	MKS 1968 - 6 - 0 - 1818	49,7	42,5
20	MKS 1970 - 6 - 0 - 2020	54,7	47,5

* nur geeignet für Federleisten MKF 13216/13316 und MKH 5132

* only suitable for connectors MKF 13216/13316 and MKH 5132