

SWITCHING APPLICATION.  
INTERFACE CIRCUIT AND DRIVER CIRCUIT APPLICATION.

#### FEATURES

- With Built-in Bias Resistors.
- Simplify Circuit Design.
- Reduce a Quantity of Parts and Manufacturing Process.

#### EQUIVALENT CIRCUIT

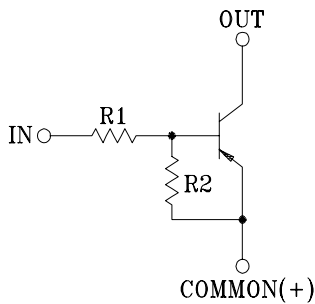

#### BIAS RESISTOR VALUES

TYPE NO.	R1(kΩ)	R2(kΩ)
KRA101S	4.7	4.7
KRA102S	10	10
KRA103S	22	22
KRA104S	47	47
KRA105S	2.2	47
KRA106S	4.7	47

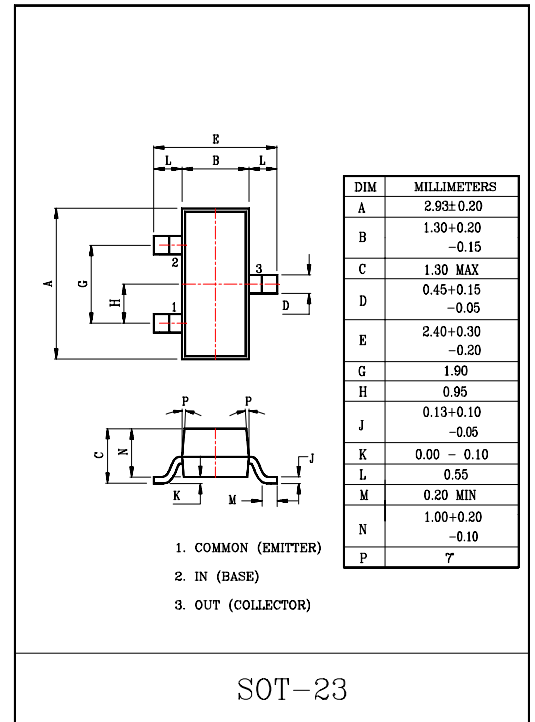

#### MAXIMUM RATINGS (Ta=25°C)

CHARACTERISTIC		SYMBOL	RATING	UNIT
Output Voltage	KRA101S~106S	V <sub>O</sub>	-50	V
Input Voltage	KRA101S	V <sub>I</sub>	-20, 10	V
	KRA102S		-30, 10	
	KRA103S		-40, 10	
	KRA104S		-40, 10	
	KRA105S		-12, 5	
	KRA106S		-20, 5	
Output Current	KRA101S~106S	I <sub>O</sub>	-100	mA
Power Dissipation		P <sub>D</sub>	200	mW
Junction Temperature		T <sub>j</sub>	150	°C
Storage Temperature Range		T <sub>stg</sub>	-55~150	°C

#### MARK SPEC

TYPE	KRA101S	KRA102S	KRA103S	KRA104S	KRA105S	KRA106S
MARK	PA	PB	PC	PD	PE	PF

#### Marking

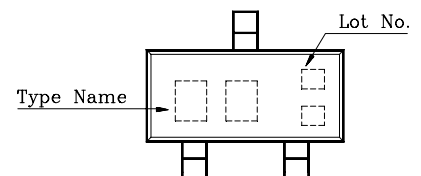

# KRA101S ~ KRA106S

## ELECTRICAL CHARACTERISTICS (Ta=25°C)

CHARACTERISTIC		SYMBOL	TEST CONDITION	MIN.	TYP.	MAX.	UNIT
Output Cut-off Current	KRA101S~106S	$I_{O(OFF)}$	$V_O=-50V, V_I=0$	-	-	-500	nA
DC Current Gain	KRA101S	$G_I$	$V_O=-5V, I_O=-10mA$	30	55	-	
	KRA102S			50	80	-	
	KRA103S			70	120	-	
	KRA104S			80	200	-	
	KRA105S			80	200	-	
	KRA106S			80	200	-	
Output Voltage	KRA101S~106S	$V_{O(ON)}$	$I_O=-10mA, I_I=-0.5mA$	-	-0.1	-0.3	V
Input Voltage (ON)	KRA101S	$V_{I(ON)}$	$V_O=-0.2V, I_O=-5mA$	-	-1.5	-2.0	V
	KRA102S			-	-1.8	-2.4	
	KRA103S			-	-2.1	-3.0	
	KRA104S			-	-2.8	-5.0	
	KRA105S			-	-0.8	-1.1	
	KRA106S			-	-0.9	-1.3	
Input Voltage (OFF)	KRA101S~104S	$V_{I(OFF)}$	$V_O=-5V, I_O=-0.1mA$	-1.0	-1.2	-	V
	KRA105S~106S			-0.5	-0.65	-	
Transition Frequency	KRA101S~106S	$f_T *$	$V_O=-10V, I_O=-5mA$	-	200	-	MHz
Input Current	KRA101S	$I_I$	$V_I=-5V$	-	-	-1.8	mA
	KRA102S			-	-	-0.88	
	KRA103S			-	-	-0.36	
	KRA104S			-	-	-0.18	
	KRA105S			-	-	-3.6	
	KRA106S			-	-	-1.8	

Note : \*Characteristic of Transistor Only

# KRA101S ~ KRA106S

## ELECTRICAL CHARACTERISTICS (Ta=25°C)

CHARACTERISTIC		SYMBOL	TEST CONDITION	MIN.	TYP.	MAX.	UNIT
Switching Time	Rise Time	KRA101S	V <sub>O</sub> =-5V V <sub>IN</sub> =-5V R <sub>L</sub> =1kΩ	-	0.07	-	μS
		KRA102S		-	0.06	-	
		KRA103S		-	0.2	-	
		KRA104S		-	0.24	-	
		KRA105S		-	0.02	-	
		KRA106S		-	0.07	-	
	Storage Time	KRA101S		-	1.1	-	
		KRA102S		-	1.1	-	
		KRA103S		-	1.1	-	
		KRA104S		-	1.1	-	
		KRA105S		-	1.1	-	
		KRA106S		-	1.1	-	
	Fall Time	KRA101S		-	0.15	-	
		KRA102S		-	0.24	-	
		KRA103S		-	0.38	-	
		KRA104S		-	0.63	-	
		KRA105S		-	0.1	-	
		KRA106S		-	0.2	-	

# KRA101S ~ KRA106S

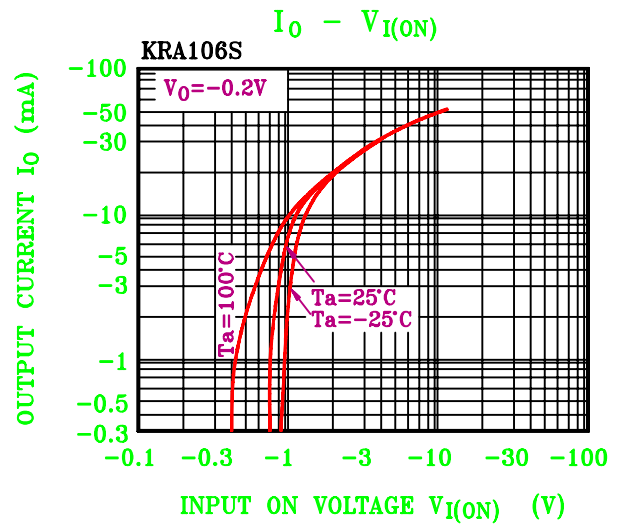
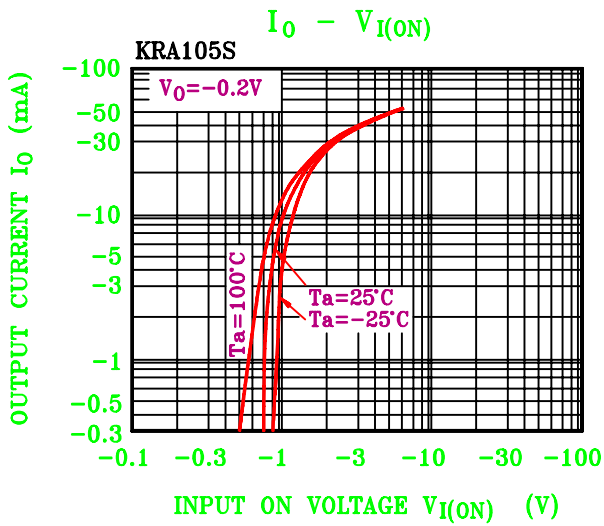
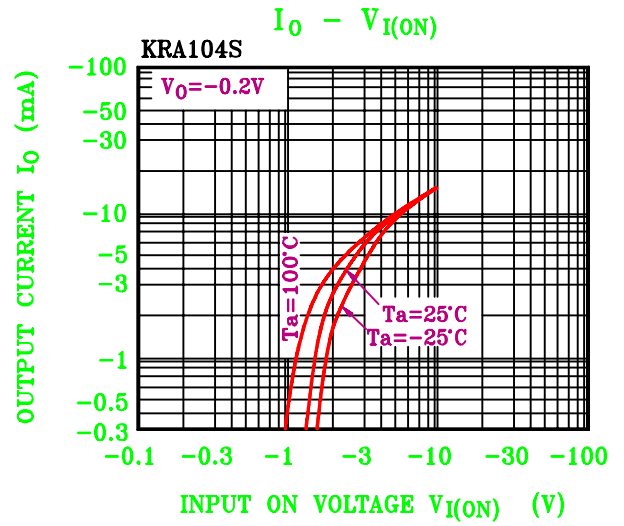
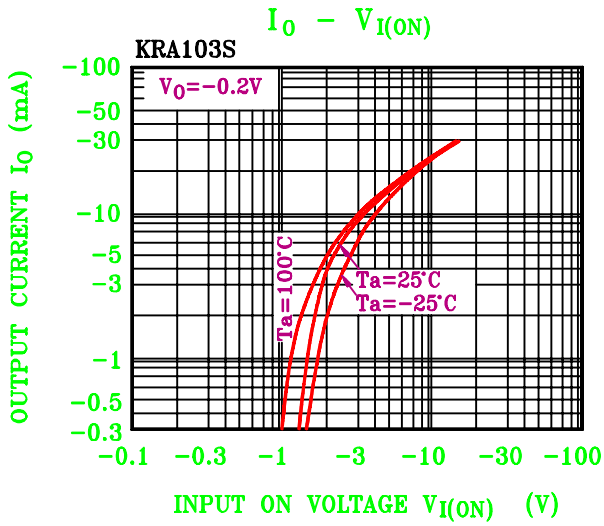
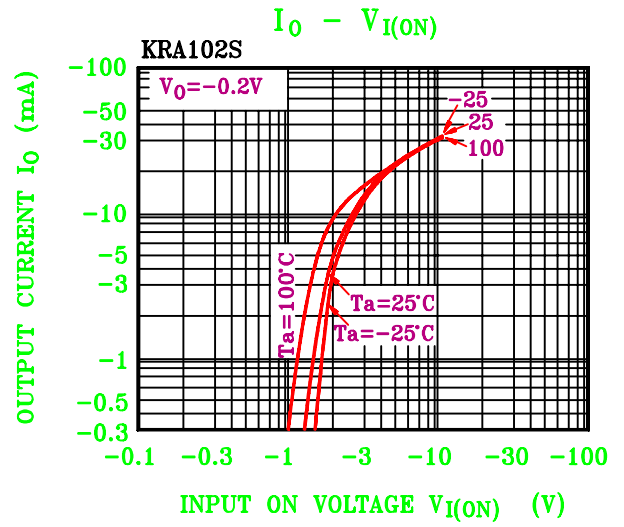
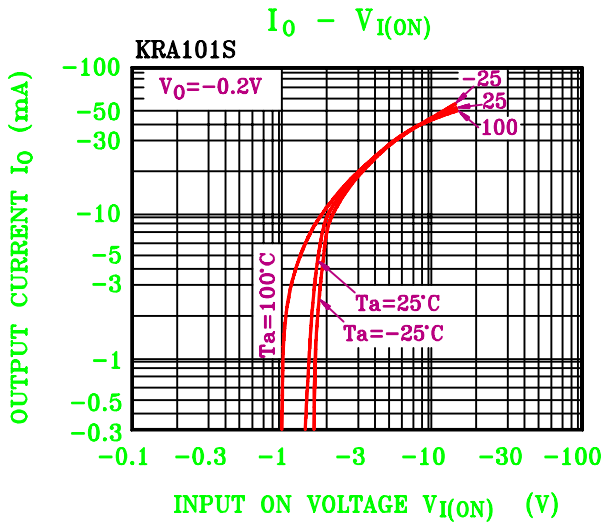

# KRA101S ~ KRA106S

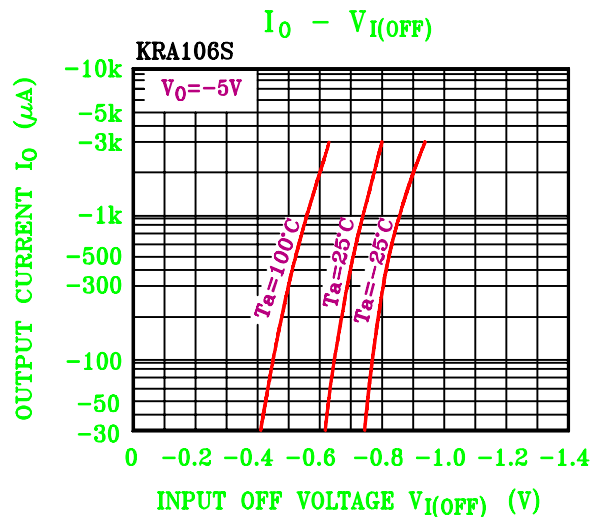
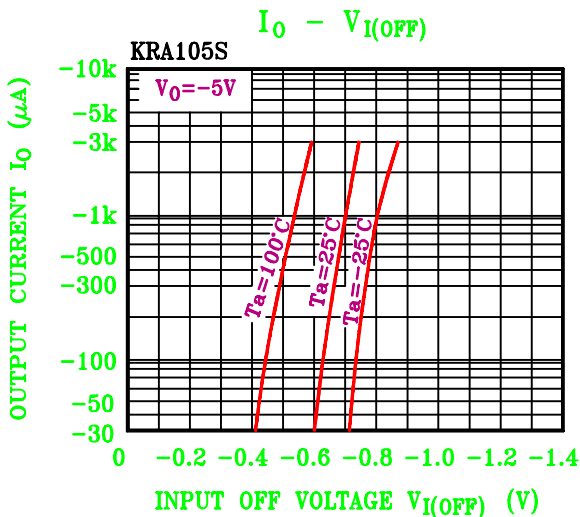
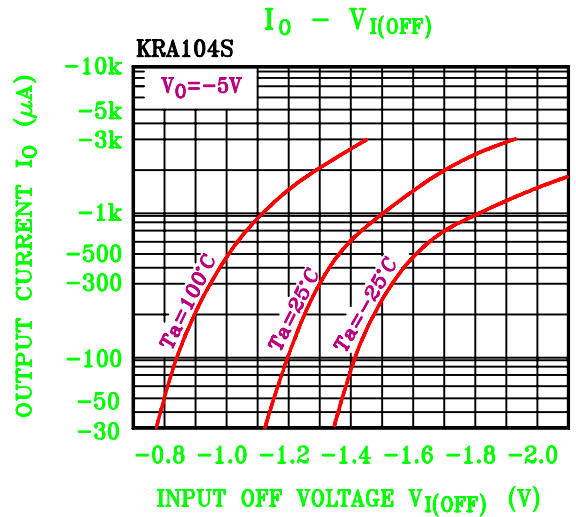
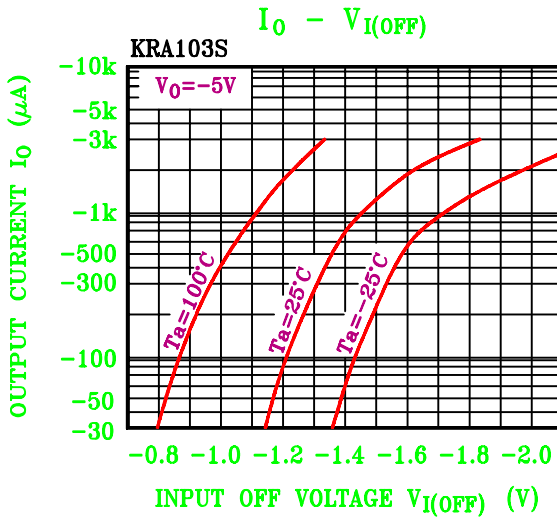
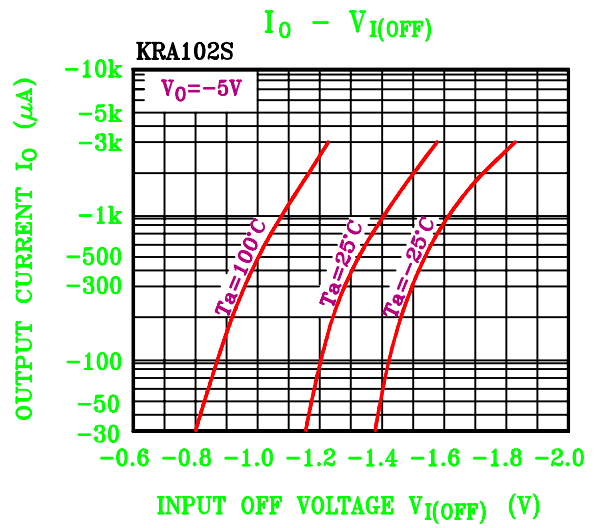
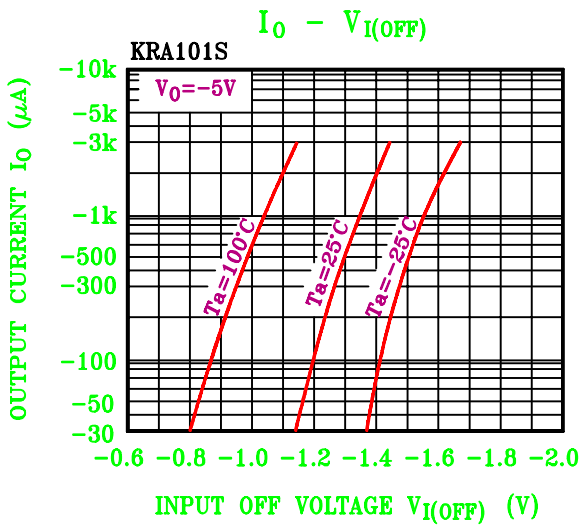

# KRA101S ~ KRA106S

