

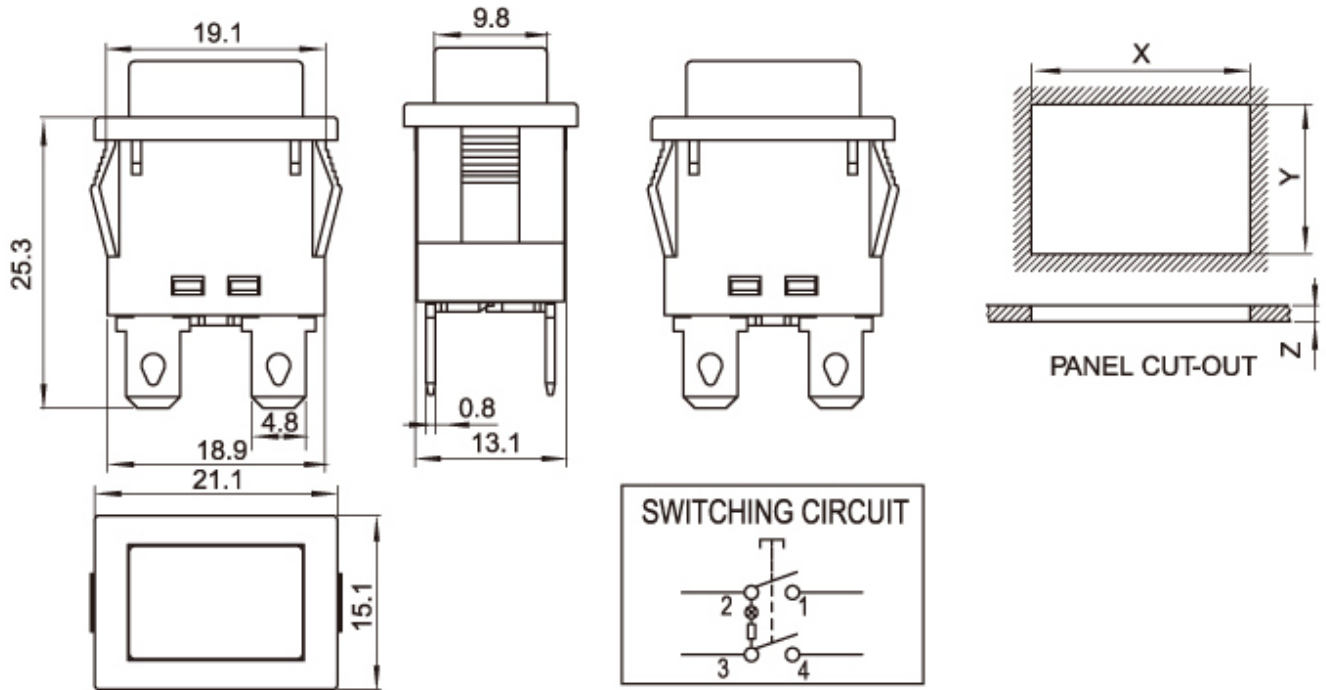

# PS102-212A001WBS







PANEL CUT-OUT		
Z	Y	X
0.70~1.25	13~13.2	18.9~19.1
1.25~2.00	13~13.2	19.1~19.2
2.00~3.00	13~13.2	19.3~19.4

# PS102 SERIES

額定電流、電壓 RATING

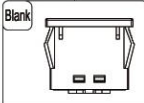
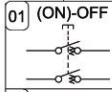
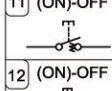
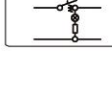
16A 250VAC

接觸電阻 CONTACT RESISTANCE	≤ 20mΩ
絕緣電阻 INSULATION RESISTANCE	≥ 100MΩ
介電強度 DIELECTRIC INTENSITY	≥ 1800VAC/3S
電器壽命 ELECTRICAL LIFE	≥ 10,000 Cycles

PS102	1	01	0	01	2	B	B	C
系列号 Series	极 Poles	电路图 Circuit diagram	带灯状况 Illuminated	按钮标志 Button Mark	端子规格 Terminal Type	按钮颜色 Actuator Colour	底座颜色 Base Colour	带锁状况 Locking Condition
Blank 	1 单极 single Pole  2 双极 Double Pole	01 (ON)-OFF  11 (ON)-OFF  12 (ON)-OFF 	0 不带灯 NO Illuminated 带灯 Illuminated	00 02 ON 05 OFF 06 - 14 NO	1 4.8mm TAB 0.8mm THICK  2 4.8mm TAB 0.8mm THICK  3 6.3mm TAB 0.8mm THICK  4 6.3mm TAB 0.8mm THICK 	B 黑色 Black G 绿色 Green A 灰色 Gray Y 黄色 Yellow R 红色 Red W 白色 White L 蓝色 Blue O 橘黄色 Orange P 紫色 Purple	B 黑色 Black G 绿色 Green A 灰色 Gray Y 黄色 Yellow R 红色 Red W 白色 White L 蓝色 Blue O 橘黄色 Orange P 紫色 Purple	不带锁 NO Locking S 带锁 Locking