

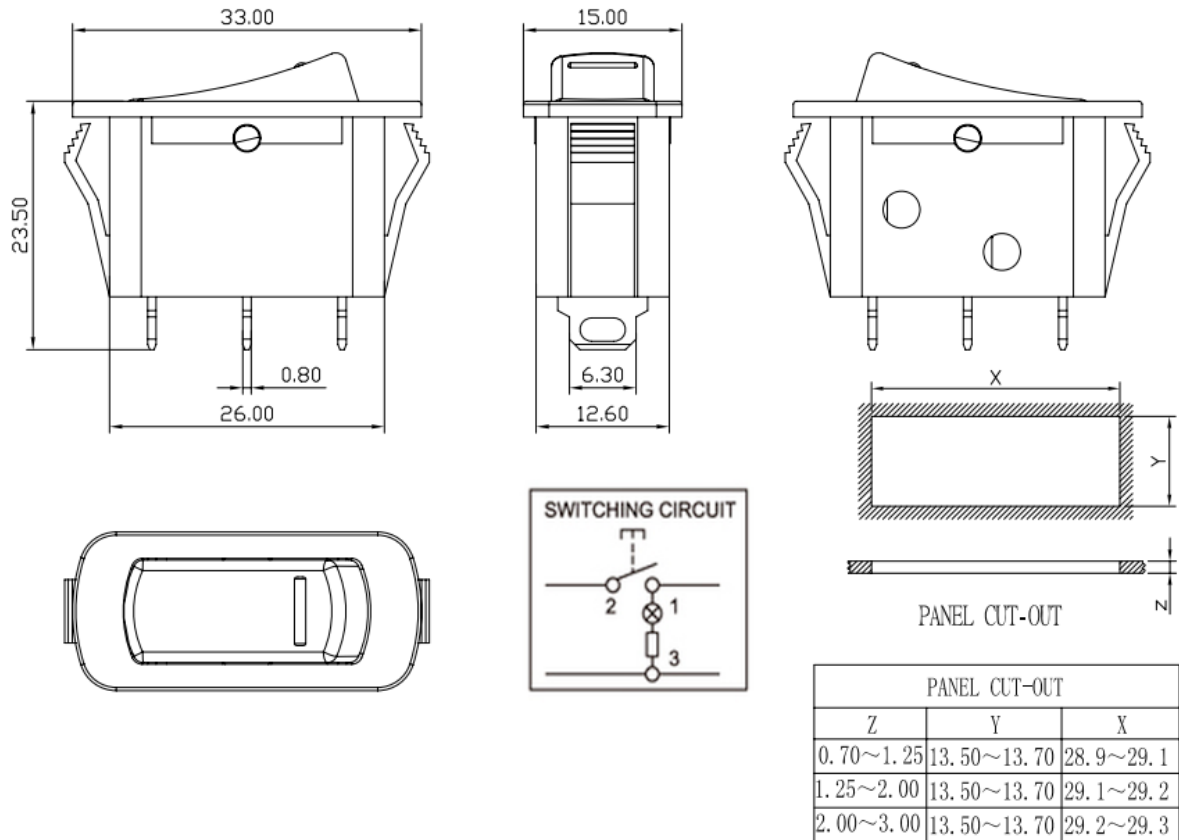

RS606C-101N001CRB



RS606 SERIES

額定電流、電壓 RATING

16(4)A 250VAC T85

20A 250VAC/25A 250VAC T105

16A 250VAC/16A 125VAC T125

接觸電阻 CONTACT RESISTANCE

≤ 20mΩ

絕緣電阻 INSULATION RESISTANCE













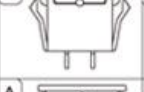

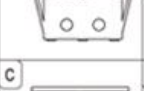



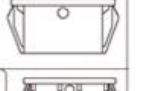
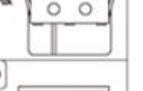

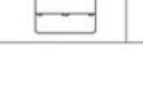



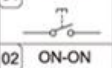
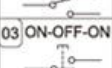
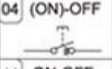

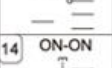















≥ 100MΩ

介電強度 DIELECTRIC INTENSITY

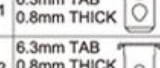
≥ 1800VAC/3S

電器壽命 ELECTRICAL LIFE

≥ 10,000 Cycles

RS606	1	01	0	01	2	C	B	B
系列号 Series	极 Poles	电路图 Circuit diagram	带灯状况 Illuminated	按钮标志 Button Mark	端子规格 Terminal Type	按钮类型 Actuator Type	按钮颜色 Actuator Colour	底座颜色 Base Colour
底座类型 Base Type Blank 双极  Blank  A  A 双极  B  C  E  AD  A1  B 双极  D  EF  F 	1 单极 single Pole  2 双极 Double Pole 	01 ON-OFF  02 ON-ON  03 ON-OFF-ON  04 (ON)-OFF  11 ON-OFF  12 ON-OFF  13 ON-ON  14 ON-ON 	0 不带灯 NO Illuminated N 220V 氖灯(红色) 220V Neon Lamp A 220V 氖灯(绿色) 220V Neon Lamp B 220V 氖灯(蓝色) 220V Neon Lamp C 6V 钨丝灯(绿色) 6V Tungsten Bulb D 12V 钨丝灯(绿色) 12V Tungsten Bulb E 110V 氖灯(蓝色) 110V Neon Lamp F 24V 钨丝灯(红色) 24V Tungsten Bulb I 12V 钨丝灯(红色) 12V Tungsten Bulb J 12V LED灯(绿色) 12V LED Lamp L 220V LED灯(红色) 220V LED Lamp M 24V LED灯(红色) 24V LED Lamp Q 110V 氖灯(红色) 110V Neon Lamp	00  01 o -  02 NO  03 o  04 o  05 •  06 -  07  08 OFF ON  09 - o  10 o  11 = -  12 < >  13 •  14 ON  15  17 O 	1 6.3mm TAB 0.8mm THICK  2 6.3mm TAB 0.8mm THICK Tin Bronze  3 6.3mm TAB 0.8mm THICK Tin Bronze 	A  B  C  E 	B 黑色 Black G 绿色 Green A 灰色 Gray Y 黄色 Yellow R 红色 Red W 白色 White L 蓝色 Blue O 橘黄色 Orange P 紫色 Purple	B 黑色 Black G 绿色 Green A 灰色 Gray Y 黄色 Yellow R 红色 Red W 白色 White L 蓝色 Blue O 橘黄色 Orange P 紫色 Purple